



ALFA GIULIETTA
BUSINESS EDITION





NEW ALFA GIULIETTA

COUPÉ LOOKS WITH 5-DOOR PRACTICALITY

STYLE

- Aerodynamic design
- Sleek lines
- Coupé style
- Rear spoiler
- Sporty front seats
- High quality Italian upholsteries

EFFICIENCY

- Alfa MultiAir engine (up to 10% less emissions)
- Second-generation MultiJet diesel engines
- ALFA TCT semi-automatic transmission
- Start&Stop engine system
- Gear Shift Indicator



BUSINESS EDITION

SAFETY & TECHNOLOGY

- Euro NCAP 5-star rating*
- 6 airbags
- VDC with Hill Holder and Electronic Q2 differential
- Uconnect™ 6.5" colour touchscreen navigation and infotainment system with Bluetooth® and DAB radio
- Tyre Pressure Monitoring System (TPMS)
- Front and rear parking sensors

*From 2010 assessment

DYNAMICS & COMFORT

- Alfa D.N.A. (Vehicle's driving mode selector)
- Alfa Active Steering with Dual Pinion
- MacPherson Strut independent front suspension
- Multilink independent rear suspension
- Dual zone auto climate control
- Cruise control & electric lumbar support
- Auto headlights and windscreen wipers





DESIGN AND FUNCTIONALITY

- Three-spoke leather steering wheel with central aluminium insert inspired by the Alfa Romeo grille.
- Clean contemporary style dashboard with driver focused Uconnect™ colour touchscreen infotainment system.
- High quality Italian upholsteries with matching door panel and dashboard inserts.
- Sporty front seats with enveloping and supportive design.
- Available in Competizione cloth or full sports leather upholsteries.
- Choice of 8 exterior Metallic or Special paint colours, including iconic Alfa Red, as a no cost option.



Alfa D.N.A. – derived from racing technology, Alfa D.N.A. is the exclusive Alfa Romeo driving mode selector which perfectly adapts the vehicle’s performance to suit both the driver’s style and road conditions. There is a choice of three modes: DYNAMIC which optimises performance, NATURAL for optimum fuel economy and ALL-WEATHER for tackling bad weather and low grip conditions. It’s simple and intuitive, just flick the switch near the gear knob to change the setup of the engine, brakes, steering and accelerator to suit the driving conditions.

ALFA TCT – this is the innovative twin dry clutch semi-automatic transmission, consisting of two gear boxes in parallel that allow the next gear to engage while the previous one is still engaged. It therefore offers continuous torque delivery without losing power when shifting gears, making them faster and slicker. The result is a driving comfort and sporty feel that far surpasses those offered by traditional automatic transmissions.

UCONNECT™ – an advanced multimedia system that integrates all of the vehicles technological functions in a single device that can be operated through the steering wheel mounted controls, colour touchscreen display or via the latest voice recognition software*. The Uconnect™ 6.5" Radio Nav features full GPS Satellite Navigation system with preloaded 3D maps to get you to your destination every time. The colour touchscreen allows you to manage the DAB radio, media player (Via USB, SD card reader or Aux-in) and phone† (Bluetooth® hands free with SMS reader).



*Voice recognition software applicable for specific functions only
†List of compatible mobile phones is available online at www.alfaromeo.co.uk

PRICES AND STANDARD EQUIPMENT



	VERSION CODE	BASIC PRICE	VAT	RETAIL PRICE	OTR CHARGES	TOTAL OTR	BIK RATE (BENEFIT IN KIND)	P11D
PETROL								
1.4 TB MultiAir 170 hp ALFA TCT Business Edition	191.C5G.1	£16,837.06	£3,367.41	£20,204.47	£695.53	£20,900.00	17%	£20,845.00
DIESEL								
1.6 JTD _{M-2} 120 hp Business Edition	191.C5R.1.BUS	£15,320.39	£3,064.08	£18,384.47	£695.53	£19,080.00	17%	£19,025.00
2.0 JTD _{M-2} 150 hp Business Edition	191.C5S.1.BUS	£16,403.73	£3,280.75	£19,684.48	£695.53	£20,380.00	20%	£20,325.00
2.0 JTD _{M-2} 175 hp ALFA TCT Business Edition	191.C5T.1	£18,203.73	£3,640.75	£21,844.48	£695.53	£22,540.00	20%	£22,485.00

ON THE ROAD (OTR) CHARGES INCLUDE:

First 12 months government Vehicle Excise Duty (£0 for all Business Edition models), vehicle first registration fee (£55), number plate (£25.53) and delivery costs (£615).

	START & STOP	ENGINE CAPACITY (CC)	HP	0 - 62 MPH (SEC)	TOP SPEED (MPH)	INSURANCE GROUP	EMISSIONS CO ₂ (G/KM)	URBAN MPG (L/100KM)	EXTRA URBAN MPG (L/100KM)	COMBINED MPG (L/100KM)
PETROL										
1.4 TB MultiAir 170 hp ALFA TCT Business Edition	STD	1368	170	7.6	135	23	114	44.8 (6.3)	68.9 (4.1)	57.7 (4.9)
DIESEL										
1.6 JTD _{M-2} 120 hp Business Edition	STD	1598	120	10.0	121	18	99	60.1 (4.7)	88.3 (3.2)	74.3 (3.8)
2.0 JTD _{M-2} 150 hp Business Edition	STD	1956	150	8.8	130	23	110	56.5 (5.0)	76.4 (3.7)	67.3 (4.2)
2.0 JTD _{M-2} 175 hp ALFA TCT Business Edition	STD	1956	175	7.8	136	24	113	55.4 (5.1)	74.3 (3.8)	65.7 (4.3)

BENEFIT-IN-KIND TAXATION

The company car Benefit-in-Kind Taxation scale is linked to the CO₂ emissions level. The BIK rate column above shows the percentage of the car price to be taxed (P11D value). Below you can also find a simple explanation useful to calculate the BIK.

EXAMPLE OF HOW TO CALCULATE BIK

Look at the table above and for the engine of your choice use the 'BIK Rate' percentage for the calculation below.

The car's price to be taxed (P11D value) includes: Total Retail Price (Basic Price + VAT) + Number Plate (£25.53) + Delivery costs (£615) + Option (Including VAT)

Calculate the BIK as follows: P11D value x % of car price to be taxed

For more information about the Company Car Benefit-In-Kind Taxation Charges see the Alfa Romeo website: www.alfaromeo.co.uk



Driver focused technology



Hi-Fi Bose® sound system (optional)



Bi-Xenon adaptive front headlights with headlight washer system (optional)



Front fog lights (standard)

STANDARD & OPTIONAL EQUIPMENT



WHEELS	BUSINESS EDITION	CODE
16" Turbine design alloy wheels with 205/55 R16 tyres	•	431
17" Burnished double spoke design alloy wheels with 225/45 R17 tyres	£490.00	421
17" Multi-spoke design alloy wheels with 225/45 R17 tyres	£100.00	433
17" Turbine design alloy wheels with 225/45 R17 tyres	£200.00	420
18" 5 Hole design alloy wheels with 225/40 R18 tyres ⁽¹⁾	£650.00	439
18" Turbine design alloy wheels with 225/40 R18 tyres ⁽¹⁾	£650.00	435
18" Multi-spoke design alloy wheels with 225/40 R18 tyres ⁽¹⁾	£650.00	4AY
Space saver 16" spare steel wheel	•	803
Space saver 17"/18" spare steel wheel	£0.00 ⁽²⁾	4UE

EXTERIOR		
Special paint	£0.00	Δ ⁽³⁾
Metallic paint	£0.00	Δ ⁽⁴⁾
Dark tinted windows	£210.00	070
Electric double sunroof ⁽⁵⁾	£1,200.00	400
Fog lights	•	097
Chrome effect wing mirrors	•	4YD
Red Brembo brake calipers ⁽⁶⁾	£500.00	4SU

INTERIOR		
Competizione cloth upholstery	•	-
Sports leather upholstery ⁽⁷⁾	£1,540.00	212
Rear armrest with storage compartment, third rear head restraint and through-load system	£320.00	275
Front armrest	•	132
Height adjustable passenger seat	•	454
Electrically adjustable, heated front seats with electric lumbar adjustment and memory setting on driver's side ^(8/9)	£1,250.00	177/452
Electric lumbar adjustment on driver and passenger seats	•	40Y
Heated front seats	£260.00	452
Aluminium sports pedals	£160.00	4CS
Floor mats	£40.00	396
Smoking kit	£80.00	989

COMFORT & SAFETY	BUSINESS EDITION	CODE
Bluetooth® hands-free system with voice recognition and steering wheel controls	•	-
Rear parking sensors and multifunctional display	•	52B/4GF
Front parking sensors	•	508
TPMS (Tyre Pressure Monitoring System)	•	-
Dual zone automatic climate control	•	140
Cruise control	•	416
Steering wheel paddles for ALFA TCT gearbox	£260.00	4WE
Headlight washer system	£210.00	102
Bi-Xenon adaptive front headlights with headlight washer system	£930.00	102/230
Alfa code immobiliser and alarm system	•	213
Visibility Pack (Rain, dusk & condensation sensors, electrochromic rear view mirror with deactivation button and electric folding wing mirrors)	•	7DA
Premium Pack (Bi-Xenon adaptive front headlights with headlight washer system, Hi-Fi BOSE® sound system, Electric double sunroof) ⁽¹⁰⁾	£2,500.00	7DD

TECHNOLOGY		
Alfa D.N.A.	•	-
DAB radio	•	-
Uconnect™ 6.5" colour touchscreen Radio Nav with preloaded 3D Maps, Bluetooth® audio streaming, Voice recognition, USB, SD reader & Aux-in)	•	6ZB
Hi-Fi BOSE® sound system with digital amplifier (8 speakers + 1 central + subwoofer) ⁽¹⁰⁾	£820.00	718

Δ Footnote

(1) Not available with the 1.6 JTDm-2 120 hp engine. (2) Only available with 17" or 18" optional wheel. (3) Refer to colour table. (4) Refer to colour table. (5) Option 400 must be ordered with option 5KW (Darkened interior headlining). Price of option 400 includes the price of option 5KW. (6) Only available with 17" or 18" alloy wheels. (7) Option 212 must be ordered with option 275 (Rear armrest with storage compartment, third rear head restraint and through-load system). Price of option 212 does not include the price of option 275. (8) Option 177 is only available in conjunction with option 212 and 275. Price of option 177 does not include the price of options 212 and 275. (9) Option 177 comes equipped with option 40Y (Electric lumbar adjustment on driver and passenger seats) as standard. (10) When selected with 16" alloy wheel the space saver spare wheel is replaced with Fix&Go puncture kit.

Standard • Footnote Δ



Alfa D.N.A. (standard)



Electric front and rear windows (standard)









Steering wheel mounted controls (standard)

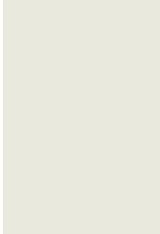

Red leather interior with rear armrest (optional)

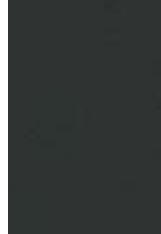
BODY COLOURS, SEATS & WHEELS

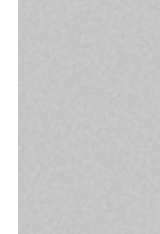

SPECIAL		METALLIC					
							
289 Alfa Red	296 Ghiaccio White	318 Magnesio Grey	319 Antracite Grey	486 Cobalto Blue	805 Etna Black	620 Alfa Silver	764 Luna Pearl

COMPETIZIONE CLOTH		SPORTS LEATHER		
				
168 Grey	689 Black-Antracite	465 Tan	401 Red	408 Black

STANDARD		OPTIONAL				
						
431 16" Turbine design alloy wheels with 205/55 R16 tyres	421 17" Burnished double spoke design alloy wheels with 225/45 R17 tyres	433 17" Multi-spoke design alloy wheels with 225/45 R17 tyres	420 17" Turbine design alloy wheels with 225/45 R17 tyres	439 18" 5 Hole design alloy wheels with 225/40 R18 tyres	435 18" Turbine design alloy wheels with 225/40 R18 tyres	4AY 18" Multi-spoke design alloy wheels with 225/40 R18 tyres



Leather steering wheel (standard)*



Uconnect™ 6.5" Radio Nav (standard)



Quartz dashboard insert (standard)

*Red steering wheel stitching with leather interior only

ENGINES & DIMENSIONS



FEATURES	1.4 TB MultiAir 170 hp ALFA TCT	1.6 JTDm-2 120 hp	2.0 JTDm-2 150 hp	2.0 JTDm-2 175 hp ALFA TCT
Fuel	Petrol	Diesel		
No. of cylinders, arrangement	4 in line			
Bore x stroke (mm)	72 x 84	79.5 x 80.5	83.0 x 90.4	
Displacement (cc)	1368	1598	1956	
Compression ratio	9.8:1	16.5:1		
Max. power output hp (kW - EC) at rpm	170 (125) 5500	120 (88) 3750	150 (110) 3750	175 (128.5) 3750
Peak torque Nm (kgm - EC) at rpm	250 (25.5) 2500	320 (32.6) 1750	380 (38.7) 1750	350 (35.7) 1750
ELECTRICAL EQUIPMENT (12V)				
Battery: Capacity (Ah)/Generator (A)	63/450	72/600		
TRANSMISSION				
Drive	Front			
Number of gears	6+1R			
TYRES				
Standard version	205/55 R16			
STEERING SYSTEM				
Steering diameter kerb-to-kerb (m)	10.9			
SUSPENSION				
Front	MacPherson independent with anti-roll bar			
Rear	Multilink System			
BRAKES				
Front (mm)	305	281	305	
Rear (mm)	264			
WEIGHTS - TANK CAPACITY				
Fuel tank (lit.)	60			
Kerb weight DIN (kg)	1305	1310	1320	1335
PERFORMANCE				
Top speed (mph)	135	121	130	136
Acceleration (driver + 30 kg) 0-62 (s)	7.6	10.0	8.8	7.8
FUEL CONSUMPTION - EMISSIONS*				
Urban cycle mpg (l/100km)	44.8 (6.3)	60.1 (4.7)	56.5 (5.0)	55.4 (5.1)
Extra-urban cycle mpg (l/100km)	68.9 (4.1)	88.3 (3.2)	76.4 (3.7)	74.3 (3.8)
Combined cycle mpg (l/100km)	57.7 (4.9)	74.3 (3.8)	67.3 (4.2)	65.7 (4.3)
Exhaust emissions - CO ₂ (g/km)	114	99	110	113
Emissions Standard	Euro 6			
Start&Stop	Standard			
BUSINESS EDITION OTR PRICE				
	£20,900	£19,080	£20,380	£22,540

*Fuel consumption and CO₂ values are obtained for comparative purposes in accordance with EC directives/regulations and may not be representative of real life driving conditions. Factors such as driving style, weather and road conditions may also have a significant effect on fuel consumption.

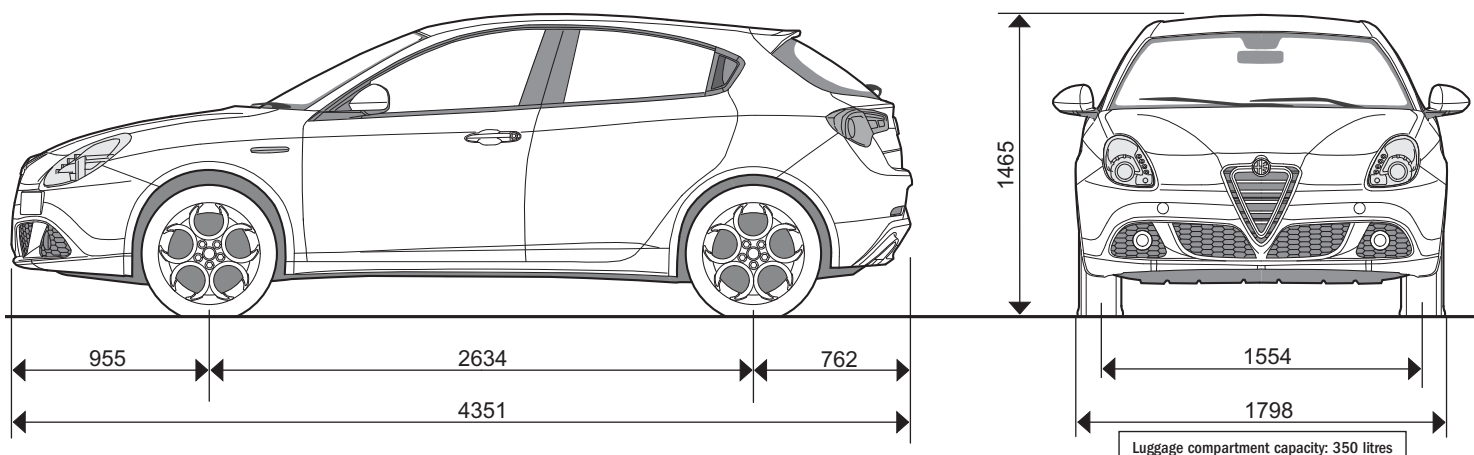

MOPAR PRODUCTS & SERVICES



The mission of Mopar® is to ensure customers of all brands within Fiat Chrysler Automobiles a satisfying ownership experience for the vehicle's entire life cycle, putting their after-sales service leadership and know-how at their service. Mopar® looks after cars from the moment they leave the dealership onwards, guaranteeing the customer the very highest level of service, employing cutting-edge technology and innovative, original and high-quality products.

MANUFACTURER'S WARRANTIES

3 Year Manufacturer's Warranty

Your 3 year warranty comprises of a manufacturer's 24 month warranty and a further 12 months dealer warranty, guaranteeing your vehicle against any manufacturer's defects. These warranties give you complete peace of mind during the first 3 years of ownership so that should any components fail due to manufacturing defects these will be replaced with genuine Alfa Romeo parts, free of charge. Full terms and conditions are available on request and listed in your owner's manual.

8 Year Anti-Perforation Warranty

Any perforation of the bodywork due to corrosion will be replaced free of charge during the first 8 years.

3 Year Paintwork Warranty

In the unlikely event of any paintwork defects, due to faulty materials or manufacture, we will rectify these free of charge during the first 3 years.

3 YEARS FREE ROADSIDE ASSISTANCE

The Alfa Romeo Assistance Service provides help in the event of your vehicle developing a mechanical or electrical breakdown at either the roadside or your home. The service is designed to get your car moving as soon as possible. In the event that the fault cannot be fixed at the roadside, then your car will be taken to your nearest authorised dealership and you will be offered assistance to continue with your onward journey. Full terms and conditions are available on request.

The Alfa Romeo Assistance Service for customers is guaranteed 24 hours a day, every day of the year. If you require these services, dial the Freephone number 00800 0426 5337.

EASY CARE SERVICING PLANS

The Easy Care servicing plan is a 3 year annual service plan applicable for every Alfa Romeo model† for one standard price. The plan includes all of your essential servicing requirements, containing three annual services for 3 years taken in accordance with the maintenance schedule shown. The price includes all the parts, labour and fluids required to perform the service schedule created for your car. For more information please contact your Alfa Romeo dealer.

Servicing Schedule

PETROL	DIESEL	PRICE
9,000 mls	12,000 mls	£499
18,000 mls	24,000 mls	
27,000 mls	36,000 mls	

ACCESSORIES & MERCHANDISE

An extensive range of genuine accessories and merchandise is available - please visit your local dealer or go to www.alfaaccessories.com



†Please note this Maintenance Plan excludes Alfa Romeo 4C and Alfa Romeo 4C Spider.

FINANCIAL SERVICES

ALFA ROMEO FINANCIAL SERVICES*

Alfa Romeo Financial Services offers a comprehensive range of finance and insurance plans including Alfa Romeo Preferenza, traditional Hire Purchase, Guaranteed Asset Protection Insurance and SMART Repair Insurance. Please ask your Alfa Romeo dealer for more information or visit the www.alfaromeo.co.uk website. Written quotations available on request.

ALFA ROMEO CONTRACT HIRE**

Alfa Romeo Contract Hire provides hassle free motoring for private and business customers - you benefit from low initial outlay, regular rentals and no worry about disposing of your vehicle at the end of the contract. You can also include a full maintenance package within the monthly rental. For more information please contact your Alfa Romeo dealer. Written quotations available on request.



**FINANCIAL
SERVICES**



**CONTRACT
HIRE**

*Alfa Romeo Financial Services is a trading style of FCA Automotive Services UK Ltd. FCA Automotive Services UK Ltd is authorised and regulated by the Financial Conduct Authority (Firm Reference Number 312683 and CCI-IP-421472). Credit available to anyone aged 18 or over subject to status. A guarantee may be required. Written quotations are available from Alfa Romeo Financial Services, PO Box 4465, Slough, SL1 0RW.

**Alfa Romeo Contract Hire is a trading style of FCA Fleet Services UK Ltd. FCA Fleet Services UK Ltd holds Interim Permissions with the Financial Conduct Authority for credit purposes (CCI-IP-439467). Credit available to anyone aged 18 or over subject to status. A guarantee may be required. Contract Hire facilities are available subject to credit approval. Written quotations are available from Alfa Romeo Contract Hire, PO Box 4590, Slough, SL1 0WU.

INFORMATION & NEWS

ALFA ROMEO NEWSLETTER

The Alfa Romeo newsletter offers an exclusive insight into everything Alfa Romeo: from eagerly anticipated new models to celebrating the heritage of the brand. Get the latest news sent straight to your inbox by registering your details at:

WWW.ALFAROME.CO.UK/NEWSLETTER

SOCIAL COMMUNITIES

Our social channels are a place for people to share their passion for Alfa Romeo with each other and us. With over 100,000 active members, it's your chance to join a community, discover breaking news, enter exclusive competitions and be a part of the Alfa Romeo story. Join the conversation on:



TEST ME

FOR FURTHER INFORMATION,
AND TO BOOK A TEST DRIVE CONTACT OUR
BUSINESS CENTRE AT:

ALFAROME.FLEET@ALFAROME.CO.COM

OR CALL: 08466 623621†
(LINES OPEN MON - FRI 9AM - 5PM)
WWW.ALFAROME.CO.UK

†CALLS CHARGED AT LOCAL RATE



www.alfaromeo.co.uk

DOWNLOAD

Alfa Romeo InfoMobile

The App that offers info, services and assistance



CALL

Alfa InfoMore

00 800 2532 0000

Freephone number for info

SHARE ON

SocialNetWall

socialnetwall.alfaromeo.com



Products offered for sale may differ from those described or illustrated in this price list due to later production changes in specifications, components or place manufacture. The contents of this price list are therefore to be treated as representations as to the current availability of products as described, or as to products actually offered for sale. Alfa Romeo UK, a trading name of Fiat Chrysler Automobiles UK Ltd reserves the right to make changes at any time, without notice, to prices, colours, materials, equipment, specification and models and also to discontinued models. All details correct at time of going to print.

Alfa Romeo - Marketing - 02.9.0000.02 - S - 06/15 - Printed in England - Vario Press Limited

A brand of

FCA

FIAT CHRYSLER AUTOMOBILES